

Surface Mount Schottky Barrier Rectifier
Reverse Voltage - 20 to 200 V
Forward Current - 1.0 A

FEATURES

- Metal silicon junction, majority carrier conduction
- For surface mounted applications
- Low power loss, high efficiency
- High forward surge current capability
- For use in low voltage, high frequency inverters, free wheeling, and polarity protection applications

MECHANICAL DATA

- Case: SMAF
- Terminals: Solderable per MIL-STD-750, Method 2026
- Approx. Weight: 27mg / 0.00095oz

PINNING

PIN	DESCRIPTION
1	Cathode
2	Anode

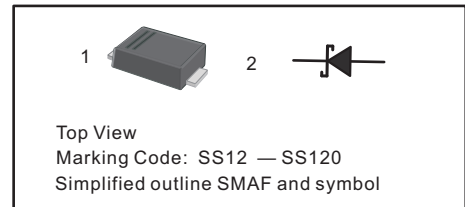

Absolute Maximum Ratings and Electrical characteristics

Ratings at 25 °C ambient temperature unless otherwise specified. Single phase, half wave, 60Hz resistive or inductive load, for capacitive load, derate by 20 %

Parameter	Symbols	SS12F	SS14F	SS16F	SS18F	SS110F	SS112F	SS115F	SS120F	Units
Maximum Repetitive Peak Reverse Voltage	V_{RRM}	20	40	60	80	100	120	150	200	V
Maximum RMS voltage	V_{RMS}	14	28	42	56	70	84	105	140	V
Maximum DC Blocking Voltage	V_{DC}	20	40	60	80	100	120	150	200	V
Maximum Average Forward Rectified Current	$I_{F(AV)}$	1.0								A
Peak Forward Surge Current, 8.3ms Single Half Sine-wave Superimposed on Rated Load (JEDEC method)	I_{FSM}	30								A
Max Instantaneous Forward Voltage at 1 A	V_F	0.55		0.70		0.85		0.90		V
Maximum DC Reverse Current $T_a = 25^\circ\text{C}$ at Rated DC Reverse Voltage $T_a = 100^\circ\text{C}$	I_R	0.3 10				0.2 5		0.1 2		mA
Typical Junction Capacitance ⁽¹⁾	C_j	110			80					pF
Typical Thermal Resistance ⁽²⁾	$R_{\theta JA}$	95								°C/W
Operating Junction Temperature Range	T_j	-55 ~ +125								°C
Storage Temperature Range	T_{stg}	-55 ~ +150								°C

(1) Measured at 1 MHz and applied reverse voltage of 4 V D.C

(2) P.C.B. mounted with 2.0" X 2.0" (5 X 5 cm) copper pad areas.

Fig.1 Forward Current Derating Curve

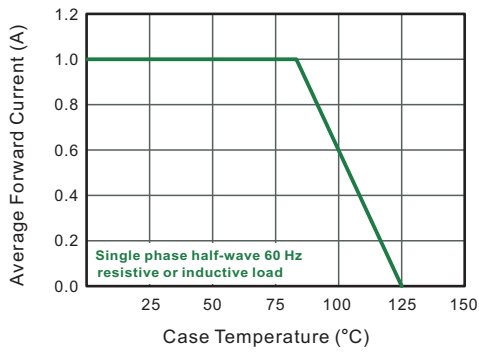

Fig.2 Typical Reverse Characteristics

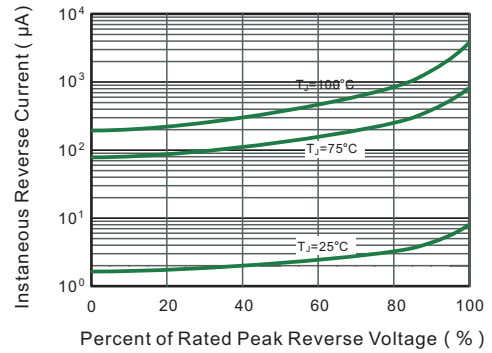

Fig.3 Typical Forward Characteristic

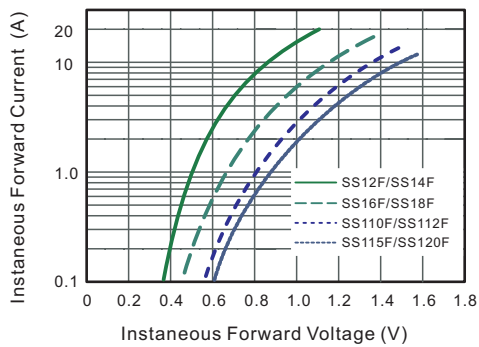

Fig.4 Typical Junction Capacitance

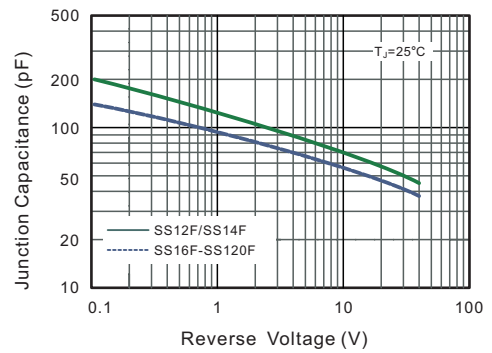

Fig.5 Maximum Non-Repetitive Peak Forward Surge Current

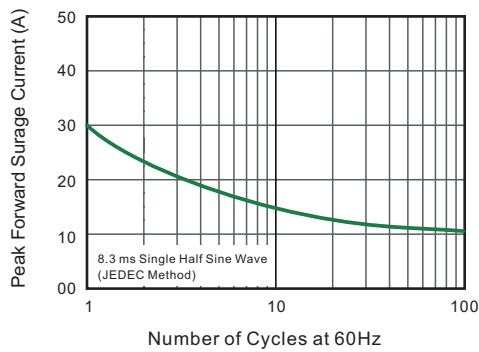
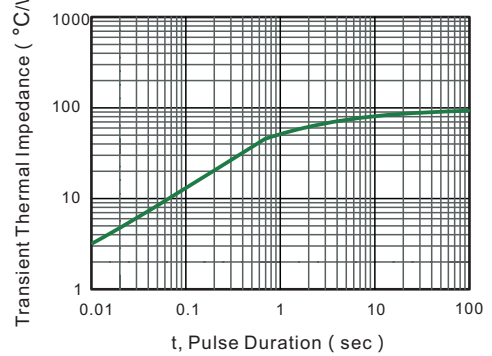

Fig.6- Typical Transient Thermal Impedance



PACKAGE OUTLINE

Plastic surface mounted package; 2 leads

SMAF

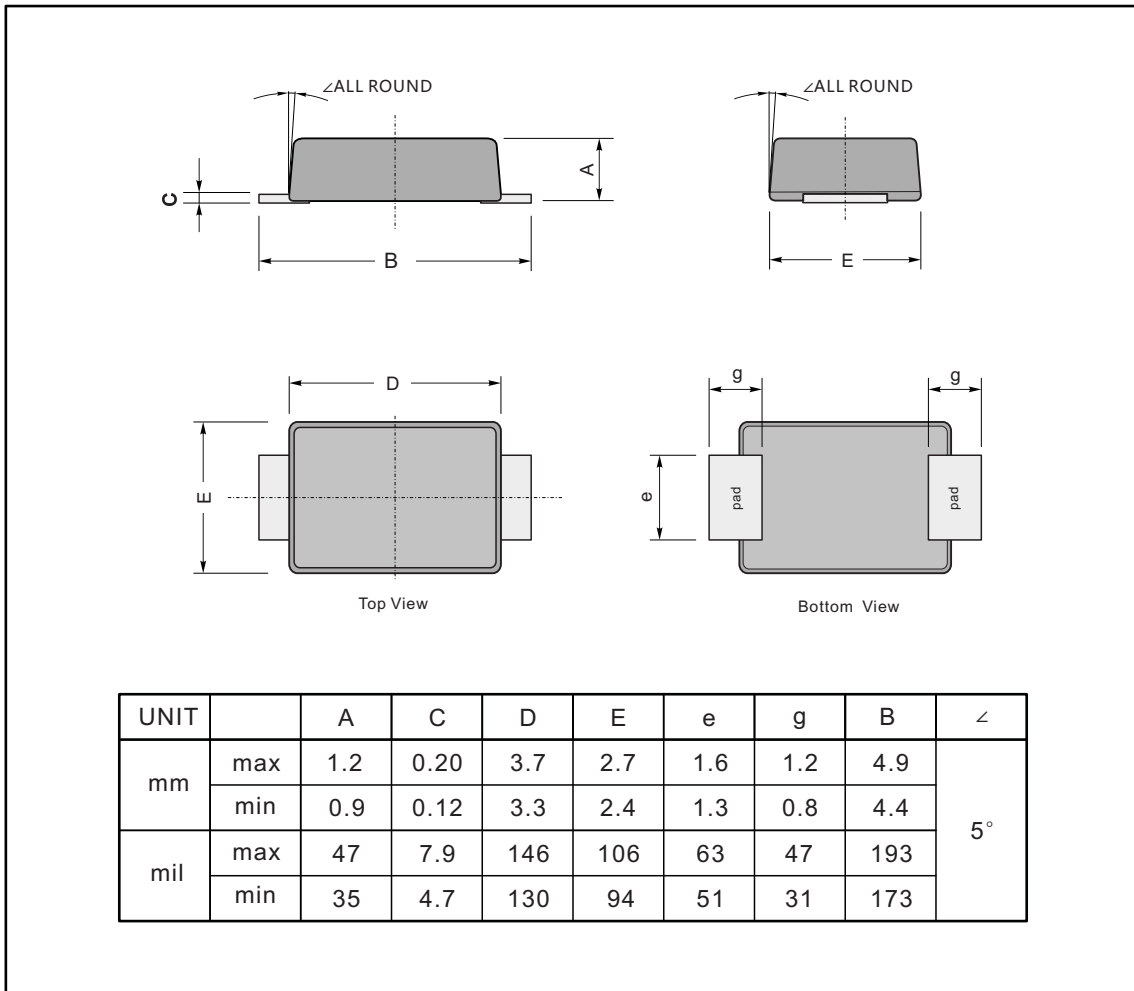

The recommended mounting pad size

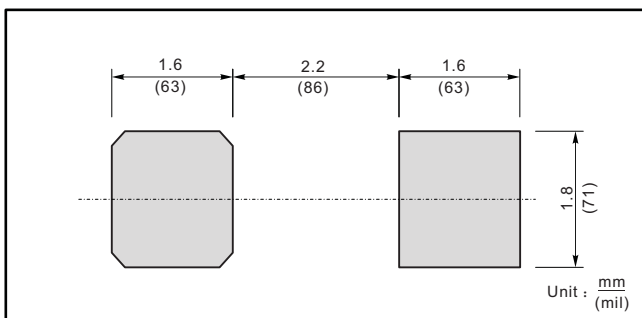

Marking

Type number	Marking code
SS12F	SS12
SS14F	SS14
SS16F	SS16
SS18F	SS18
SS110F	SS110
SS112F	SS112
SS115F	SS115
SS120F	SS120